

Dirello

ITALIAN OUTDOOR DESIGN

PERGOLE
BIOCLIMATICHE

SCHEDA TECNICA

PER
GAL _7.7

**BREVETTO
DEPOSITATO**



PER GAL 7.7

100% made in Italy



Caratteristiche tecniche Pergal 7.7

- > Brevetti depositati;
- > Dimensioni: fino a 700 x 700 cm per modulo;
- > Design del modello versione addossata;
- > Struttura in alluminio con componenti Inox;
- > Verniciatura a polveri epossidiche resistenti ai raggi UV;
- > Marcatura CE;
- > Made in Italy.

Complementi

- > Faretto LED ad incasso da integrare nel frangisole,
- > App per la gestione delle automazioni utilizzabile da Smartphone e Tablet;

Vantaggi

- Pre-assemblaggio testato**
- > Prodotto interamente pre-assemblato, collaudato in fabbrica e consegnato all'installatore in macro assiemi per l'installazione facilitata.

VERNICIATURE STANDARD //

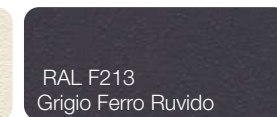
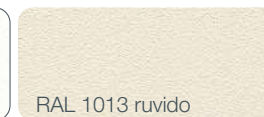



PERGAL 7.7 // DETTAGLI TECNICI

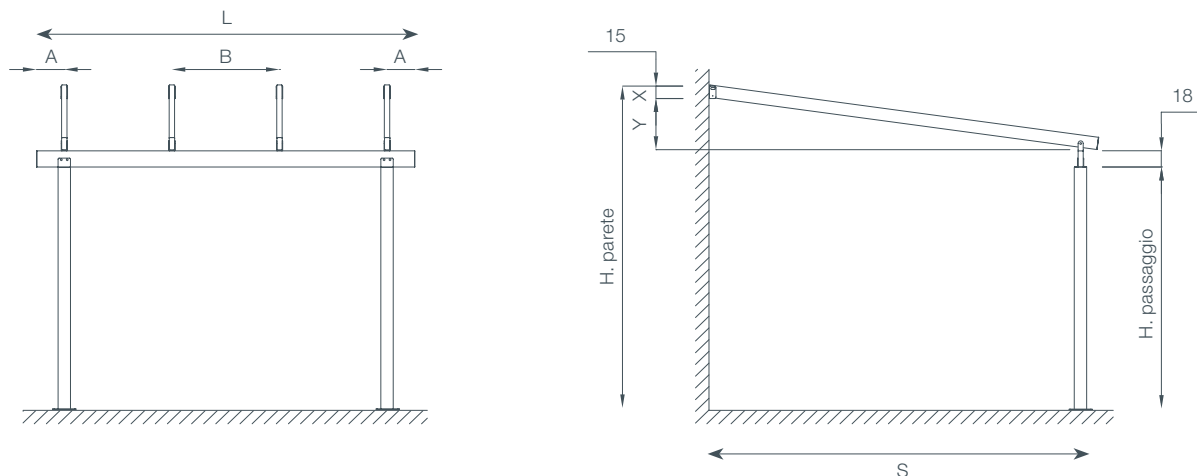

A	distanza arcarecci esterni dalle estremità
B	interasse arcarecci interni
L	larghezza totale
S	sporgenza totale
Y	pendenza
HP	altezza passaggio
X	ingombri

A	min distanza	5 cm
A	max distanza	25 cm
B	max larghezza interasse guide interne	125 cm
L	max larghezza totale	700 cm
L	max larghezza totale con 2 arcarecci	160 cm
L	max larghezza totale con 3 arcarecci	300 cm
L	max larghezza totale con 4 arcarecci	400 cm
C	max larghezza totale con 5 arcarecci	500 cm
L	max larghezza totale con 6 arcarecci	600 cm
L	max larghezza totale con 7 arcarecci	700 cm
S	max sporgenza totale	700 cm
X	ingombri	
HP	max altezza passaggio	250 cm

PROFILI //

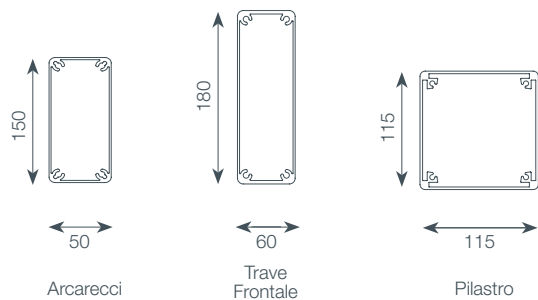

SUPPORTI DI FISSAGGIO //

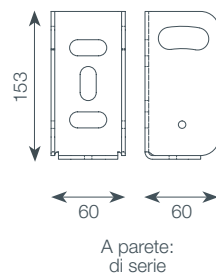

PIASTRE A PAVIMENTO //

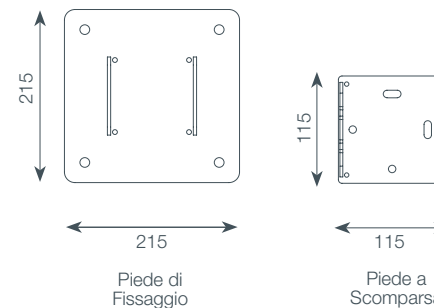

SAGOMATURE //

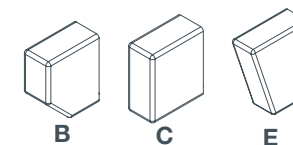

PERGAL 7.7 // OPTIONALS

PILASTRO LATERALE //

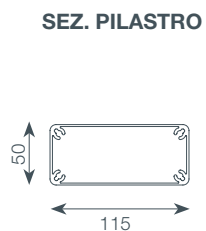
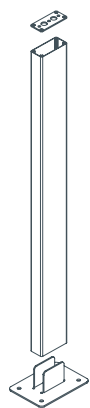

SEZ. PILASTRO PILASTRO LATERALE

Profilo estruso in alluminio completo di accessori e lavorazioni

PILASTRO FRONTALE //

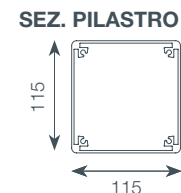

SEZ. PILASTRO PILASTRO FRONTALE

Profilo estruso in alluminio completo di accessori e lavorazioni

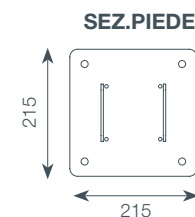

SEZ. PIEDE PILASTRO FRONTALE

Staffaggio realizzato in acciaio inox con trattamento di verniciatura alle polveri poliesteri.

TRAVE A MURO //

Consente l'ancoraggio a parete semplice e veloce.

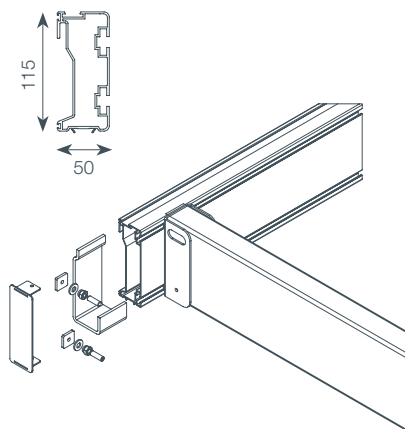

SPOT LED //



SPOT LED è la linea di faretti LED ad incasso, completi di trasformatore, da integrare negli arcarecci. La luce diffusa è di un bianco intenso.

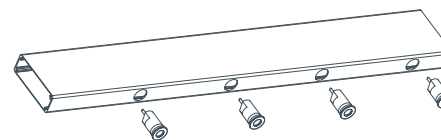

SPOT LED AD INCASSO

Luce Fredda 6000k Bianco 3w - 12 V 180lm

LIGHTING RECEIVER VARIATION IO

Ricevitore luci dimmerabile per un sistema di illuminazione LED. Tecnologia IO - Home control integrabile con altri dispositivi IO. Potenza massima 500 Watt cad.



VERNICIATURE

VERNICIATURE STANDARD // STRUTTURA E LAME

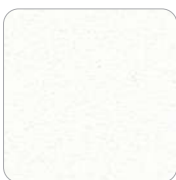

RAL 9010
ruvido

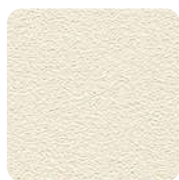

RAL 1013
ruvido



F213 Grigio Ferro
ruvido

Possibilità di ordinare strutture bicolore unicamente per i colori standard.

il simbolo * indica le verniciature standard, ma con tempi di consegna superiori.

VERNICIATURE SPECIALI // +15%



RAL 7035
ruvido

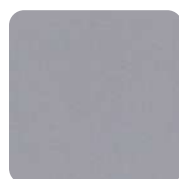

RAL 9006
metallizzato opaco

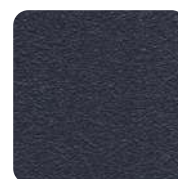

RAL 7016
ruvido



RAL 7001
ruvido



RAL 7037
ruvido



RAL 7034
ruvido

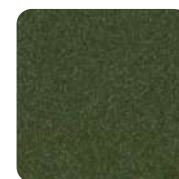

RAL 6003
ruvido



RAL 6005
ruvido

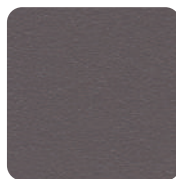

RAL 7039
ruvido

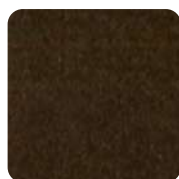

RAL 8014
ruvido

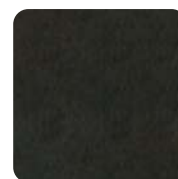

RAL 8019
ruvido



F206 Marrone Cuoio
ruvido



RAL 7006
ruvido



F235 Corten
puntinato ruvido

il simbolo + indica le verniciature speciali con costi supplementari e tempi di consegna superiori.

COLORI PARTI IN NYLON //

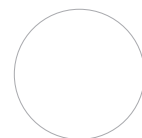

Bianco



Avorio



Grigio Ferro



Grigio



Tortora

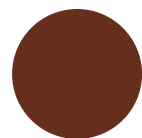

Corten



Verde

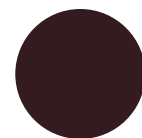

Marrone

Le riproduzioni delle verniciature sono da ritenersi indicative.

La verniciatura a polveri dei nostri profili si suddivide sostanzialmente in tre cicli:

- > pretrattamento chimico applicato sul profilo grezzo per ottenere finiture perfette e durevoli nel tempo;
- > applicazione della polvere poliestere mediante pistole elettrostatiche automatiche;
- > polimerizzazione a 200° per ottenere un rivestimento finale resistente aumentando le caratteristiche meccaniche del profilo stesso.

Dirello

ITALIAN OUTDOOR DESIGN

Dirello S.r.l.

viale dell'Artigianato, 31
70026 / Modugno / Ba / Italia
t. +39 080 532 0903
t. +39 080 532 6287
f. +39 080 530 9255
P.IVA / C.F.: IT 07831630723
info@dirello.com
dirello.com



dirello.com

Follow us:

facebook

twitter



YouTube

Google+

LinkedIn



by



LQIR\$HUR0DVELRF0LPDWLFDVQHW

